

---

---

## THE EFFECTS OF AIRLIFT CIRCULATION ON THE SPACIAL DISTRIBUTION OF *Crassostrea gigas* OYSTER LARVAE SET ON STRUNG CULTCH IN CIRCULAR TANKS

Fred S. Conte, Michael Oliver, and Heidi Johnson

California's coastal water temperature is too cold in summer for successful reproduction of *Crassostrea gigas*, the Pacific oyster. Oyster growers rely on shipments of shell with attached young (spat) or advanced larvae, both produced in U.S. based hatcheries. Hatchery personnel harvest the "eyed larvae" when they are about 21 days old, able to swim, about 300 microns in size, and at a stage just prior to settlement, metamorphosis, and attachment to a substrate. Several million larvae are then chilled, wrapped in a moist towel, packaged, and shipped to be set at growout sites. To set the seed, the larvae are re-suspended in tanks containing heated seawater (24-25° C) and clean oyster or scallop shell (cultch) on stringers or in mesh bags and are allowed to set as attached spat in about three days. This process is called remote setting of oyster larvae.

Although growers have been successful in producing oyster seed, they report that there is great variability in the number of spat achieved per piece of cultch. Sometimes the cultch contains no spat at all (blanks). Research was established using commercial setting tanks and examining set performance following 30-day hardening of the seed in nursery bays. After baseline data was obtained, the setting tank design was changed from one that used internal bubblers to circulate and aerate the water and an emersion heater buried in the shell pack to heat the water to a system using airlift pipes. The airlift system was used to improve circulation within the shell pack, isolate heating

elements from the cultch, and remove the effect of air bubbles on larval distribution and setting patterns.

Tank modifications include adding a circular screen to support the shell pack 4" from the tank base. Four 3" PVC airlifts with 45° bottom cuts extend vertically through the screen and terminate at the water surface where 45° elbows direct the water current to the tanks' center. A centered, 12" diameter airlift rests on the screen and extends vertically past the water surface. Slots cut into the top direct water flow towards the tank sides, and the emersion heater is located within the pipe. Circulation is from below the screen, up through the pipes where water is aerated and heated, and down through the shell pack.

The modified tank showed improved setting characteristics over the standard tank, and the spacial distribution of spat within the modified tanks was better than in the standard setting tanks.

During the study, stringers of cultch were tagged by position in the tank, the larvae set, and 30-day post-set counts taken. Recorded were spat count, cultch type, position of spat on cultch, position of cultch on the stringer, orientation of cultch on stringer in the nursery area, and location of cultch in the setting tank by column and level. Statistical analyses were performed to compare setting efficiency between tanks and spacial distribution of spat within tanks by column and level, cultch type, and position on cultch. The modified tank showed improved setting characteristics over the standard tank, and the spacial distribution of spat within the modified tanks was better than in the standard setting tanks.

---

---

## RAPID RETRIEVAL, COMPUTER MACRO INFORMATION SYSTEM FOR EXTENSION APPLICATION

Fred S. Conte and Nicole Gibson

In our system, informational fliers containing specific aquaculture-related information... have been developed for several aquaculture species...

Although agriculture is one of California's largest market commodities, the state's major demographic profile is now urban. High density populations centered in large metropolitan areas are driving the State Legislature to increase service to urban interests. Concurrent with changing mandates is a period of diminishing state resources overall and within the university system, particularly the Land Grant universities' research and Extension outreach programs. This has stimulated interest in developing computer information delivery programs and mechanisms that allow service to new audiences without substantially reducing the original mandate to provide programs that benefit agriculture. Our objective was to develop a computer-driven, rapid-retrieval system for extending aquaculture information in response to requests from both commercial growers and the general public. This concept may be used by Extension personnel and others to make their delivery of information more efficient.

The computer program we designed is based on WordPerfect Cooperation's "macro" feature, which allows the user to record multiple keystrokes into a file that can be used repetitively. The keystrokes consist of command signals within the macro that initiate a variety of activities such as placing printer fonts within text, establishing graphics, or retrieving files, in this case, informational documents.

In our system, informational fliers containing specific aquaculture-related information, matched with accompanying letters defining each flier's use, have been developed for several aquaculture species and related areas. The system retrieves a letter and positions the cursor for address information and salutation. The letter may then be modified or personalized by the user without disrupting the driver function. Upon completion of the address block and salutation in the letter, the system retrieves the matching flier and the packet of information is printed and ready for distribution.

The system does not replace traditional Extension fliers and leaflets but serves as a supplement to these systems. Macros are developed in response to frequent requests for information that is rapidly changing, and for infrequent but important requests for which a response often takes time to develop.

The system is being installed in county offices and used by Extension personnel who normally service other agricultural clientele. This use by county advisors with other commodity appointments has expanded the effectiveness and conserved the time commitment of specialists and advisors with partial or complete aquaculture appointments. A more advanced system is being developed in response to regional and national Extension requests for both the information and computer retrieval system.

Nicole Gibson is a Secretary in the Department of Animal Science.

# MODIFICATION OF THE FATTY ACID COMPOSITION OF MILK FAT FROM THE DAIRY COW

Edward J. DePeters

Milk fat, one of the most complex fats in nature, contains as many as 500 fatty acids (FA). Most of the FA are saturated (66%), with monounsaturated (30%) and polyunsaturated (4%) FA contributing smaller proportions. Animals fats in the human diet are now under scrutiny because of the association of myristic (C14:0) and palmitic (C16:0) acids, saturated FA, with increased serum cholesterol levels. In contrast, monounsaturated FA seem to lower cholesterol. Recent information suggests that the stereospecific distribution of FA in the triglyceride structure also could be important. An unsaturated FA esterified at the sn-2 position (Fig. 1) is proposed to be better than a saturated FA. In plant oils (e.g., corn and soy oils), unsaturated FA are found at the sn-2 position, whereas in butterfat a saturated FA is most frequently found at this position. We attempted to modify the composition of milk fat by increasing the monounsaturated and decreasing the saturated FA content in the total milk fat and at the sn-2 position of milk fat.

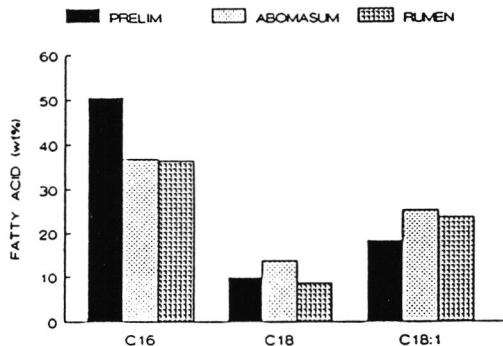

Figure 1. sn-2 fatty acids.

The objective was to evaluate the effect of dietary fat on the FA composition of milk fat. Four ruminally-fistulated, lactating Holstein cows were each fitted with a back-pack containing a battery-powered infusion pump and a bottle containing oil. Canola oil was infused continuously into either the rumen or the abomasum by placing a catheter into the rumen or through the reticulomasal orifice into the abomasum. Cows were infused for periods of 14 days.

Total FA content of palmitic acid (C16:0) was reduced, while oleic acid (C18:1) content was increased by both treatments. A similar change was observed at the sn-2 position where the proportion of C16:0 decreased but C18:1 increased (Fig. 2).

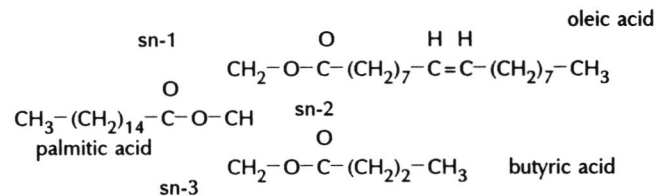

Figure 2. A structure of fat showing the sn-2 position.

In summary, increasing the cow's dietary fat increased the monounsaturated FA content of its milk fat. Dietary fat can be used to modify the total FA composition of milk fat as well as the fatty acid composition esterified at the sn-2 position. This information will permit the development of nutrition strategies for dairy cows to modify milk fat composition to meet the needs of the market place.

Dr. DePeters teaches ANS 41, Domestic Animal Production, and ANS 146, Dairy Cattle Production.

---

---

## REPRODUCTIVE CYCLES AND DOMESTIC BREEDING OF WHITE STURGEON

Serge Doroshov

A new commercial sturgeon culture was established several years ago, after the development of hatchery technology for white sturgeon by UC Davis scientists. Today, California's aquaculture industry produces high-quality, farmed sturgeon meat for the food market. However, the fingerlings for growout are still procured by capturing gravid females in the Sacramento River. Our study aims to investigate reproductive cycles of sturgeon females and establish domestic breeding.

Development of domestic sturgeon broodstock is difficult due to the late sexual maturity of this species and our inadequate knowledge of the reproductive physiology of this ancient and long-lived fish. The ovarian cycle of sturgeon in the wild and in captivity is virtually unknown. Several years ago, sturgeon farms of Northern California and UC Davis established the Sturgeon Broodstock Development Program. Researchers and farmers collaborate in field and experimental work on sturgeon farms and university facilities. In order to measure the reproductive response of sturgeon females, we established laboratory techniques based on the histochemistry and histometry of ovarian biopsies, *in vitro* oocyte incubation, and chemical and immunoassays for the sturgeon yolk precursor, vitellogenin. Our field observations were supported by the research on sturgeon endocrinology and radioimmunoassays for gonadotropins and steroid hormones established by Professor G.P. Moberg.

Recently, sturgeon farmers and university researchers finally succeeded in spawning domestic females, thus completing all stages of the life cycle of white sturgeon in captivity.

Captive female sturgeons complete their first ovarian cycle at the age of 6 to 8 years, at a body size similar to that of wild females. Ovarian development is controlled by two pituitary gonadotropins and sex steroid hormones. The cycle starts with the autogenous growth of the oocyte and differentiation of granulosa cells and egg chorion. The endogenous growth phase is followed by exogenous vitellogenesis involving secretion of vitellogenin by liver and deposition of yolk in the oocyte. Throughout the duration of vitellogenesis, the ovarian follicle undergoes complex morphogenetic and endocrine changes

resulting in egg maturation and spawning. This phase, occurring during the winter and early spring, is highly sensitive to environmental temperature. If the fish is held at water temperatures above 16° or 17° C, egg development is arrested and followed by atresia.

Recently, sturgeon farmers and University researchers finally succeeded in spawning domestic females, thus completing all stages of the life cycle of white sturgeon in captivity. However, compared with wild-caught fish, spawning performance and fry production are still inferior. At present, we are attempting to elucidate environmental factors that influence reproductive performance of domestic broodstock and optimize production of sturgeon eggs and juveniles in captivity.

Dr. Doroshov teaches ANS 118, Aquatic Animal Production; and ANS 131, Reproduction and Early Development in Aquatic Animals.

---

---

## LEAST-COST RATION SOFTWARE PROGRAMS FOR LIVESTOCK

John R. Dunbar, Abbas Ahmadi, William N. Garrett, and James W. Oltjen

"Apollo," "Pegasus," and "Taurus" are Computer Ration Programs developed for formulating and evaluating least-cost rations for swine, horses, and beef cattle. These programs were created, tested, used in education programs, and marketed by the Animal Science Department at UC Davis. They are designed to run on IBM PC-compatible computers with at least 512K of memory. The amount of typing necessary to formulate or evaluate a ration is minimized. Pop-up menus appear with a list of choices for easy entry. The arrow keys on the computer can then be used to select the entry.

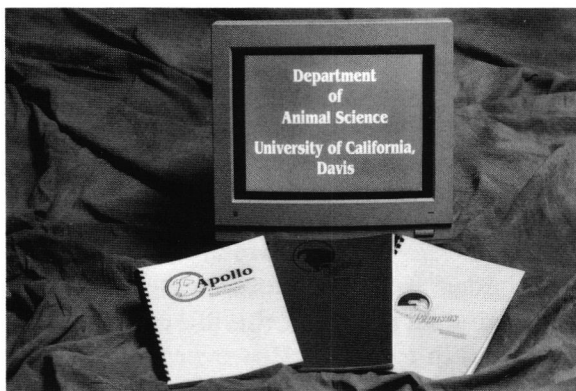

Figure 1. Computerized feed management programs.

Rations are balanced and evaluated based on NRC guidelines. Feed choices are stored in the feed library for the various species and can be selected to enter directly into the ration.

An alternate feed library can also be developed and individual feeds and nutrient analysis data can be stored. Input and output can be expressed either in English units (lb) or in metric units (kg).

The programs have been designed to be extremely user-friendly, using full-screen editing for input, pop-up help message windows, and extensive error checking. The programs calculate the nutrient analysis of the ration and flag all nutrients that are deficient or exceed the animal's requirement.

"Apollo," "Pegasus," and "Taurus" are written primarily for use by students, teachers, extension advisors, consultants, and research scientists who have a special interest in animal science, especially nutrition. Aries, Feed Tag, and Profit Projection are other programs scheduled for release in April, 1993. All these programs have received not only local and national but also world-wide interest and use. They are flexible and will be continually upgraded as new information and knowledge become available. In addition, they will be integrated with other programs not only to optimize performance but also to maximize profit.

John Dunbar is a Cooperative Extension Specialist. Mr. Ahmadi is a Computer Programmer, Dr. Garrett is Professor Emeritus, and Dr. Oltjen is an Associate Cooperative Extension Specialist.

---

---

## SUPPLEMENTS EVALUATED FOR WINTERING RANGE CALVES

John R. Dunbar

Range supplements were evaluated as potential sources of bypass protein in supplementation programs for stocker calves on annual grassland at the UC Sierra Foothill Research and Extension Center. Commercially formulated supplements (molasses-based mixtures) containing urea, bypass protein, or urea plus bypass protein were used in the study and compared with unsupplemented controls.

Each of the treatments was administered at two levels of stocking density: 6 steers were randomly assigned to a low stocking rate (one head per 5.3 acres) and 12 steers to a high stocking density (one head per 2.67 acres). The experimental area (512 acres of cleared range) was divided into 16 fields, grouped in 4 blocks of 4 fields per block. In defining the blocks we attempted to group fields that were similar (based on results of previous trials) in forage production characteristics. Animals were then assigned to one of the eight treatment groups at random.

Subsequently, each treatment was assigned to one of the 16 fields so that each treatment appeared twice in each block. As the trial progressed, animals (and thus treatments) were moved each month from one field to another so that they repeated no blocks over the 4-month supplementation period. In this way, each animal was in all four blocks,

and each treatment was exposed equally in the various types of range represented in the four blocks. Blocking the fields into groups of four made it possible for each block to contain each treatment in each year of the trial.

We have collected and analyzed two years' data. Consumption was lower during the first month on test and increased as animals became familiar with the supplements. Consumption was lower in urea-supplemented steers than in the other two groups in the first year, but there were no significant differences among groups in the second year. Stocking density had no effect on supplement consumption, although it did affect average daily gain. Calves at a low density gained more weight than high density groups. Dollar return during the supplementation phase, however, was highest from high-density groups fed a combination of urea plus bypass protein.



Stocker calves self-feeding by-pass protein supplements.

## STOCHASTIC PROGRAMMING IN DAIRY FEEDING

James G. Fadel, Heidi A. Johnson, and Richard E. Howitt

A stochastic program is being developed for feeding dairy cows that incorporates the variation of nutrients in feeds and future economic losses incurred from the current feeding program. This program addresses several questions asked by dairy producers: How much nutrient variation exists in feeds and how can this be incorporated into a feeding management program? How does the current feeding management program affect the future economic returns for a given dairy cow and how can the current feeding program be adjusted to minimize future economic losses? This stochastic program is an extension of the current linear feed formulation programs.

Figure 1 shows two hypothetical feeds. Corn has a mean protein content of 8% while alfalfa contains 22% protein. The curves shown in Figure 1 have been exaggerated to describe the theory we have incorporated into the dairy feeding program. If random samples of corn and alfalfa were taken, one would be 5 times (0.2 for corn at 8% protein compared with 0.04 for

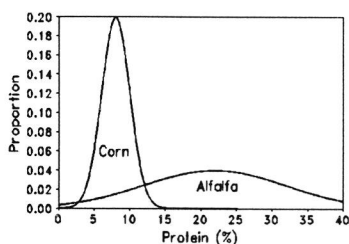

Figure 1. Proportion of sample at specified protein percentage.

alfalfa at 22% protein) more likely to obtain a corn sample with 8% protein than an alfalfa sample with 22% protein because the standard deviation of protein in corn is smaller compared to alfalfa.

Another way to examine the problem is to consider sampling from 100 lots of alfalfa and 100 lots of corn. One would expect to obtain a protein percentage of  $22 \pm 1$  in only 8 lots of alfalfa. In contrast, one would expect to obtain a protein percentage of  $8 \pm 1$  in over 38 lots of

corn. If the ration contained a high percentage of alfalfa, the intuitive approach for the dairy producer would be to increase the amount of protein in the diet. However, if over 38 lots of alfalfa had a protein percentage of  $22 \pm 1$ , then the producer would not be as concerned about meeting the protein requirements because the odds would be less that a lot of alfalfa would be selected with a low protein percentage.

The program we are developing incorporates these concepts using nonlinear programming techniques. Knowledge of the mean and the standard deviation for protein and energy are required for each ingredient in the program. Figure 2 shows what can potentially happen later in lactation when the cow is underfed nutrients in the early part of lactation. Under-feeding a cow specific nutrients, such as protein

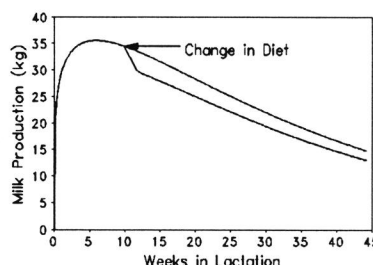

Figure 2. Change in milk production with change in diet.

or energy, can cause a decrease in milk production not only for that day but also over the long term. The producer is aware of this problem and tries to ensure that adequate nutrients are provided early in lactation. These concepts are incorporated in our model by using optimal control theory. Data are generated with a cow simulation model by varying protein and energy levels at different time frames across a 305-day lactation period. Parameters are estimated from this large data set and utilized in the stochastic program. Thus, the program we are developing maximizes profits over the entire lactation.

Dr. Fadel teaches ANS 128, Linear Programming in Animal Agriculture; NUT 122, Ruminant Nutrition and Digestive Physiology; and ANS 206, Models in Agriculture and Nutrition. Ms. Johnson is a graduate student and Staff Research Associate, and Dr. Howitt is a Professor in Agricultural Economics.

---

---

## BREEDING THE IDEAL WORK DOG: THE HERITABILITY OF BEHAVIOR IN ASSISTANCE DOGS

Thomas R. Famula

Today, there are more than 400 breeds of dog, and, accidentally or intentionally, we have selected them for a wide variety of behaviors. Whether they are helping us in hunting or herding, police work or pleasure, the behavior of dogs plays a critical role in their everyday usefulness. One particularly

demanding and important job for dogs is in assisting blind, deaf, or physically challenged people. In 1975 Canine Companions for Independence (CCI) began to pursue the development of the "service" dog, a dog that aids the physically handicapped by pulling a wheel chair, retrieving dropped items, or even turning a light switch on or off.

Of course, not all dogs are suitable for training as assistance dogs. To distinguish between those dogs suitable for training and those destined to fail the training program, the staff of CCI developed a puppy test. The original purpose of the test was to identify dogs that

had a high probability of graduating successfully from the training program. However, if successful, the puppy test can also become a useful tool for selecting parents of future generations of assistance dogs.

Our work over the past few years has been to identify how genes play a role in a puppy's performance on the test. Working with Golden and Labrador Retrievers, we have found that a combination of several of the ten different behavior tests are very good predictors of eventual graduation from assistance dog training. Furthermore, these combinations are also moderately heritable, suggesting that a selection program for these behaviors will also be useful in choosing parents of dogs of superior trainability. Although no one test of puppy behavior adequately predicts graduation success, combining the scores of several tests has been remarkably successful. In the future we will begin to use these puppy tests as selection aids. Our intent is to assess if such behavioral selection decisions really do improve the graduation rate of assistance dogs at CCI.

The original purpose of the test was to identify dogs that had a high probability of graduating successfully from the training program. However, if successful, the puppy test can also become a useful tool for selecting parents of future generations of assistance dogs.

Dr. Famula teaches ANS 1, Domestic Animals and People; ANG 108, Methods in Quantitative Animal Breeding; ANS 109, Introduction to Parameter Estimation; ANG 206, Advanced Domestic Animal Breeding; and ANG 208, Estimation of Genetic Parameters.



---

## POLITICS, ECONOMICS, AND BIOLOGY OF SALMON STOCK DEPLETION IN THE COLUMBIA RIVER BASIN

Graham A.E. Gall

The conservation of biological resources has become a national and international issue. I initiated discussion of some of these issues by organizing two workshops of international scientists to address opportunities in agriculture to contribute to the conservation of local native populations of fish, birds and other animals. This activity resulted in a book, *Integrating Conservation Biology and Agricultural Production* published by Elsevier in 1992.

For the past two years, I have been deeply involved at UC Davis and while on leave in the issues central to the loss of salmon stocks from the Columbia River Basin. Three stocks have been listed by the government as either endangered or threatened. The issues are highly political and economic and environmentally complex, since the northwestern US is highly dependent on the Columbia River and its tributaries for commerce, navigation, hydropower production, commercial, tribal and sport fishing, and recreation.

The fishery programs in the area are managed for commercial, tribal, and sport fishing. A regional power council is responsible for setting policy to balance economic and conservation uses of the river system. At least four state agencies and five federal ones are responsible for the implementation of policy. Their mandates are to examine and recommend policies for hatchery operations, habitat restoration and protection, management of the river system (dams, locks, flood control, recreation), and management of commercial and sport fishing. In addition, a major portion of the funding for fish and wildlife protection and management in the four state regions is derived from local rate-payers who derive electricity from the hydropower system. Over one billion dollars of rate-payer money was spent from 1980 to 1989 on fish and wildlife programs. The end result of these management efforts has been a demand

by conservation groups and local citizens that the fish be protected properly. Their avenue of effort has been the federal Endangered Species Act. The long-term effects of salmon protection activities could make the spotted owl controversy look mild.

The issues are complex biologically as well as politically. There are large hatchery programs that probably overtax the river system's capability to support wild fish. Habitat was badly degraded (by mining, grazing, logging, etc, ) by the turn of the century, and commercial fishing nearly eliminated most of the salmon stocks in the late 1900s. Hydropower production and flood control efforts began in the 1930s with full knowledge that salmon resources would be impacted. Even though a large quantity of data has been accumulated over the past 20 years, there is a paucity of good data upon which to base intelligent management programs. As a result there is little agreement on anything, from the nature of the problem or to how to develop solutions. Political entities seem to feel free to choose almost any stance since it is nearly impossible to document any scientifically sound argument, either pro or con. However, the data available are sufficient to initiate a sound recovery plan for salmon. The question is whether there exists a sufficient will to change.

The region is now in the midst of societal change. To what extent should the river resources be used for economic development? Who should pay for changes? How important are historical lifestyles (commercial fishing, cattle ranching, recreation, Indian tribal rights, industry, to name a few) ? Why is it important to place biological conservation at a higher priority than economic livelihood? Are the courts the proper place to find solutions? Should the Endangered Species Act be reauthorized by Congress, and if so, in what form? I anticipate the issues will magnify before they are addressed.

Dr. Gall teaches ANS107, Genetics and Animal Breeding; ANG 204, Theory of Quantitative Genetics; and GGG 201D, Quantitative and Population Genetics.

# GENETIC STUDIES OF PACIFIC AND KUMAMOTO OYSTERS

## Dennis Hedgecock

Much of our research concerns the genetic improvement of cultured oysters. West coast farms produce more oysters annually (over 10 million pounds of shucked meat) than are harvested on either the east or gulf coasts of the US. Most of these are the Pacific oyster *Crassostrea gigas*, introduced from Japan in the 1920s and now propagated by a few large hatcheries, but over 2,000 dozen of the closely related Kumamoto oyster *C. sikamea* are sold live weekly just to restaurants in Los Angeles, San Francisco, and Seattle.

A long-term project funded by the USDA's Western Regional Aquaculture Consortium has focused on creating pedigreed Pacific oyster brood stocks and partitioning variance in production traits such as growth to market size. Eight, 8 x 3 crosses, two factorial and two hierarchical, produced a first generation of nearly 192 pedigreed families, which were grown in Puget Sound, Washington, and Humboldt Bay, California. Body size at harvest (shucked meat weight at 14 to 40 months of age) was measured in over 3,600 individuals and proved highly variable with a coefficient of variation of 30%. As a result of enormous environmentally-determined

variation in growth, additive genetic components of variance estimated from sires ranged from 0.0 to 0.8 and were significant in only 4 of 12 crosses (Fig. 1). We hope to obtain statistically reliable estimates of heritability from larger, 24 x 2, hierarchical crosses being carried out this summer at the Bodega Marine Laboratory hatchery.

Some of our results also suggest that improvement of growth might be obtained by crossbreeding inbred lines, which can be made by a variety of methods including self-fertilization of occasional simultaneous hermaphrodites. We have eight inbred lines and hope to make and test dozens more under a 4-year continuation of our regional project. This project will be nicely complemented by a grant just received from the USDA to explore the fundamental genetic and physiological causes of hybrid vigor in Pacific oysters, in collaboration with colleagues from England and the University of Southern California. Allozyme and DNA markers will be used in the context of classical crossbreeding experiments to map quantitative trait loci.

We are also using modern molecular methods to gain insight into the genetics of natural and cultivated oyster populations. For example, we were recently able to clarify the biological species status of the Kumamoto oyster. Enzymatic amplification and sequencing of a mitochondrial ribosomal RNA gene revealed seven nucleotide substitutions between the morphologically similar Pacific and Kumamoto oysters (Fig. 2). These DNA differences allow rapid, precise diagnosis of Kumamoto maternal lineages (Fig. 3) and can be used, together with electrophoretically detectable protein differences, to screen commercial brood stocks, which have evidently been contaminated by admixture and hybridization with the more common Pacific oysters. The Kumamoto oyster may have disappeared from its native Japan, so there is need to conserve the genetic resources of West Coast stocks.

Components of Wet Weight Variance  
WRAC Cross D3E91 (Eureka)

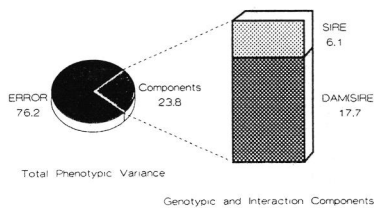
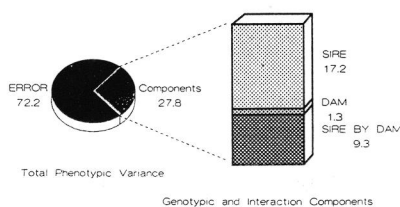

Figure 1. Components of wet weight variance in progeny from a hierarchical cross (D3E91) and a factorial cross (H1Q89) of Pacific oysters.

WRAC Cross H1Q89 (Quillcene)





## EFFECT OF DIETARY LIPIDS ON MUSCLE FATTY ACIDS IN WHITE STURGEON

Silas S.O. Hung

California farmers marketed 1.1 million pounds of sturgeon as food, mostly 8 to 12 lb fish at 2 to 3 years of age.

Although white sturgeon is a new species for aquaculture, in 1990 and 1991 California farmers marketed 1.1 million pounds of sturgeon as food, mostly 8 to 12 lb fish at 2 to 3 years of age.

Some fish have received good press as health food in recent years because they are high in  $\omega$ -3 polyunsaturated and highly unsaturated fatty acids ( $\omega$ -3 PUFA and HUFA, respectively). These fatty acids are believed to reduce the risk of cardiovascular disease in humans by lowering blood cholesterol and triglyceride levels and prolonging blood clotting time. They also lower blood pressure, curb anti-inflammatory reactions, and ameliorate tumor growth.

Fatty acid compositions in rainbow trout, salmon, and channel catfish are affected by the fatty acid composition of their diets. Furthermore, farm-raised individuals of these species generally have a lower percentage of  $\omega$ -3 PUFA and HUFA than their wild counterparts because of the lower percentage of these fatty acids in their feeds.

We attempted through diet to change the  $\omega$ -3 PUFA and HUFA

levels in sturgeon muscle. The objective of this study was to determine the fatty acid composition in the muscle of white sturgeon fed 8 very different types of lipids. The 8 lipids—corn oil, cod liver oil, lard, soybean oil, linseed oil, canola oil, and safflower oil, and control oil (corn oil:cod liver oil:lard, 1:1:1)—were included in the diets at 15% by weight. Percent  $\omega$ -3 PUFA and HUFA in these diets ranged from 0.5 to 51.7.

Growth, feed efficiency, and body compositions of sturgeon fed the different diets for 9 weeks were not significantly different ( $P > 0.05$ ). There were no adverse effects of feeding these lipids. Percent  $\omega$ -3 PUFA and HUFA in the muscle, however, reflected those in the dietary lipids, with a coefficient of determination between dietary and muscle  $\omega$ -3 PUFA and HUFA of 0.96, indicating that muscle  $\omega$ -3 PUFA and HUFA was significantly influenced by those in the diets (Table 1). Results in this study suggested that it is possible to increase the  $\omega$ -3 PUFA and HUFA in sturgeon muscle after only a short-term feeding of lipids high in these fatty acids, such as cod liver oil and linseed oil.

Table 1. Percent  $\omega$ -3 PUFA and HUFA in the diet and in sturgeon muscle after 9 weeks of feeding

	Saf- flower	Lard	Corn	Soybean	Control	Canola	Cod Liver	Linseed
	$\omega$ -3 PUFA and HUFA							
Diet	0.5	0.8	3.4	7.1	7.3	8.8	21.6	51.7
Muscle	3.8	4.8	6.0	8.6	11.1	3.8	24.7	36.6

Dr. Hung teaches NUT 110, Principles of Nutrition; and NUT 124, Nutrition and Feeding of Finfish and Shellfish.

## EFFECTS OF A $\beta$ -ADRENERGIC AGONIST, CIMATEROL, ON GROWTH, CARCASS AND SKELETAL MUSCLE CHARACTERISTICS AND MEAT QUALITY IN LAMBS

Yu Bang Lee

The administration of cimaterol (CIM) in the diet of finishing lambs (>30 kg live wt) at 5 ppm for 6 weeks significantly improved growth rate (20%), feed/gain ratio (15%), hot carcass wt (20%), dressing % (10%), and yield grade (one full US grade). CIM increased loin eye area 35%, leg conformation one full grade, and the yield of four lean cuts 28%, whereas it decreased backfat 35% and kidney and pelvic fat 25%. CIM also reduced the organ (liver, heart) weights.

CIM was effective for muscle accretion even under severely restricted feeding conditions. The greater accretion of muscle was the result of the hypertrophy of both fast-twitch and slow-twitch muscle fibers, but the hypertrophy of fast-

twitch fibers was two to three times greater than that of slow-twitch fibers. The hypertrophy of muscle fibers resulted in the shift of metabolic profile from aerobic to anaerobic metabolism in muscle. This metabolic shift reduced glycogen levels in muscle at death and consequently increased ultimate muscle pH after slaughter to higher than 5.8, compared to normal muscle pH of 5.6.

Loin chops from some CIM-fed animals with depleted muscle glycogen and subsequently high muscle pH (>6.2) at 1 day post-

mortem were as tender as those from the controls, whereas the chops from the majority (70%) of the treated lambs with pH ranges of 5.8 to 6.2 were tougher than controls. The quadratic relationship between ultimate muscle pH and meat tenderness (Fig. 1) explained the mechanism of the meat toughening effect of  $\beta$ -agonists. The intermediate pH of 5.8 to 6.2, which the majority of CIM-treated lambs had, was the optimal pH for neither calcium-dependent proteases nor the cathepsins, thus causing minimal postmortem degradation of myofibrils and consequently reduced tenderness. The average tenderness was reduced by 25%.

One-week withdrawal of CIM slightly improved the tenderness, but it was not long enough to overcome the reduced tenderness due to  $\beta$ -agonist feeding. Stress before slaughter improved the tenderness of CIM-fed lambs by depleting muscle glycogen at death and increasing the ultimate muscle pH higher than 6.2 (Fig. 1). More studies are needed to alleviate the meat toughness problem of CIM-fed animals without losing the superior muscling gained by CIM feeding. From these results, we are currently testing the hypothesis that the simultaneous determinations of cytochrome oxidase activity and ultimate muscle pH at 1 day postmortem may serve as an effective indicator of predicting final meat tenderness in beef and lamb carcasses.

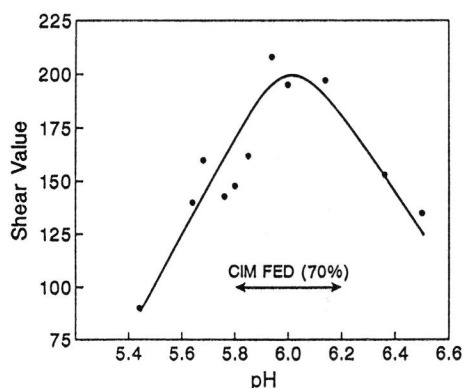

Figure 1. Quadratic relationship between final muscle pH and meat tenderness.

## BIOREMEDIATION OF SELENIUM

Joan Macy

A new selenate-respiring bacterium has been isolated, *Thauera selenatis* gen. nov. sp. nov. (Fig. 1). The organism reduces selenate to selenite under anaerobic conditions using acetate as the electron donor. This reduction is not inhibited by nitrate; instead, both electron acceptors are reduced concomitantly. In fact, nitrate must be present in order for the selenite formed to be further reduced to elemental selenium. The physiology of the organism has been studied in depth, as have all the enzymes involved in selenium metabolism. An understanding of how the organism works has made possible its use in selenium bioremediation.

*Thauera selenatis* is successfully being used in a biological reactor system for the bioremediation of selenium oxides in agricultural drainage water from the San Joaquin Valley. In this system, consisting of recycled sludge-blank and fluidized-bed reactors (Fig. 2), the organism successfully reduces the levels of selenium oxides from 350 to 450 to less than 10 ppb ( $\mu\text{g/L}$ ) when conditions are optimum; nitrate is also reduced from 40 to 65 ppm (mg/L) to less

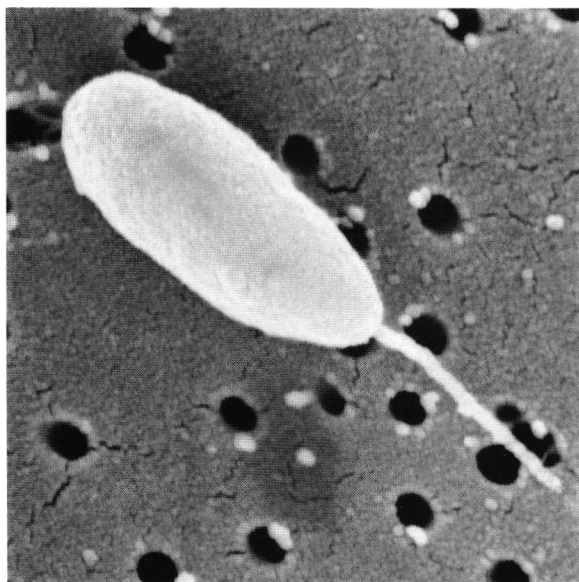

Figure 1. *Thauera selenatis* gen. nov. sp. nov.

than 1 ppm. Optimum conditions include: (a) pH of inflowing water of 6.9; (b) use of acetate (3 mM) as the carbon and energy source, since methanol will not support the growth of *Thauera selenatis*; (c) inclusion of a small amount of ammonia (0.56 mM). All elemental selenium formed can be removed by filtration.

Unlike agricultural drainage water, in which the form of selenium is selenate ( $\text{Se}^{\text{VI}}$ ), the selenium released into the San Francisco Bay from the oil refineries is selenite ( $\text{Se}^{\text{IV}}$ ). In a second reactor system of the same design, but fed water containing high levels of selenite (500-800 ppb) and low levels of selenate (<100 ppb), *Thauera selenatis* is also successfully reducing the total selenium oxides in the water to 10 ppb or less.

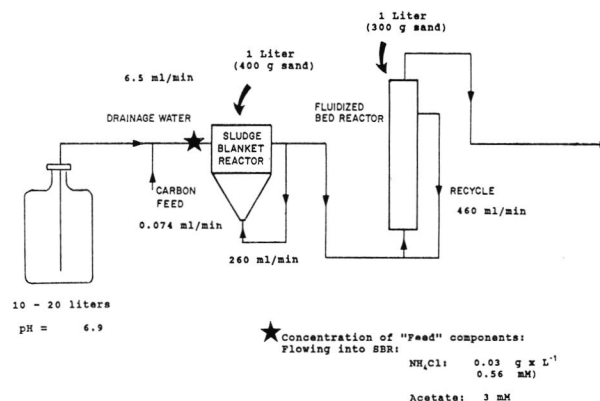

Figure 2. Recycled sludge-blank and fluidized-bed reactors.

*Thauera selenatis* has shown itself to be an effective tool for biological reduction of selenium oxides in water. Maintenance of optimum conditions for the organism is undoubtedly all that is required for effective selenium oxide reduction, no matter what the scale of the reactor system.

Dr. Macy teaches MIC 177 and MIC 177L, Metabolism of Anaerobic Bacteria, and NUT 122 and 122L, Ruminant Nutrition and Digestive Physiology.

## MOLECULAR MARKERS IN DAIRY CATTLE SELECTION

Juan F. Medrano

Remarkable genetic improvement in the dairy cattle population has taken place over the past few years as seen by a sustained 2% improvement in milk production per cow per year. This improvement has been largely accomplished by utilizing statistical evaluation systems for selecting young sires.

Evaluation of young sires by progeny testing is very accurate but requires waiting for at least partial lactation records on daughters, thus increasing generation interval. However, with the advent of new molecular technologies, methods are available that will increase accuracy of selection among young bulls and reduce the cost of progeny testing programs. In the future, these new methods will be utilized jointly with statistical techniques to continue the improvement of dairy cattle. A number of genetic markers can be identified from an animal's DNA obtained from a blood or tissue sample, and those markers that control productive traits will provide opportunity for improved selective efficiency for traits such as milk yield and milk quality. Markers of genetic disease will provide accurate and rapid detection and opportunities to control such diseases.

Since 1990, we have pioneered the development of molecular techniques to quickly and accurately classify individual cattle genotypes for  $\kappa$ -casein,  $\beta$ -lactoglobulin and  $\beta$ -casein (Figs. 1 and 2), as well as a procedure for determining sex in embryos. These innovative techniques have led to the utilization of markers to assist in selection programs by the dairy industry. The classification of the  $\kappa$ -casein genotype is now widespread throughout the industry, and it is a procedure now performed routinely by artificial insemination bull studs in the United States, Europe, and Israel.

Several studies indicate that  $\kappa$ -casein testing and selection for animals carrying the B allele has resulted in improvement of the protein content and quality of milk for cheese manufacturing. We have confirmed these results in a collaborative study with Phillip Tong's group at California State University, San Luis Obispo, evaluating Cheddar cheese yield under pilot-scale cheese making conditions.

In our continuing effort to characterize the nature of the effect of the  $\kappa$ -casein B variant, one of our graduate students, Alison Van Eenennaam, found that heterozygous  $\kappa$ -casein AB cows

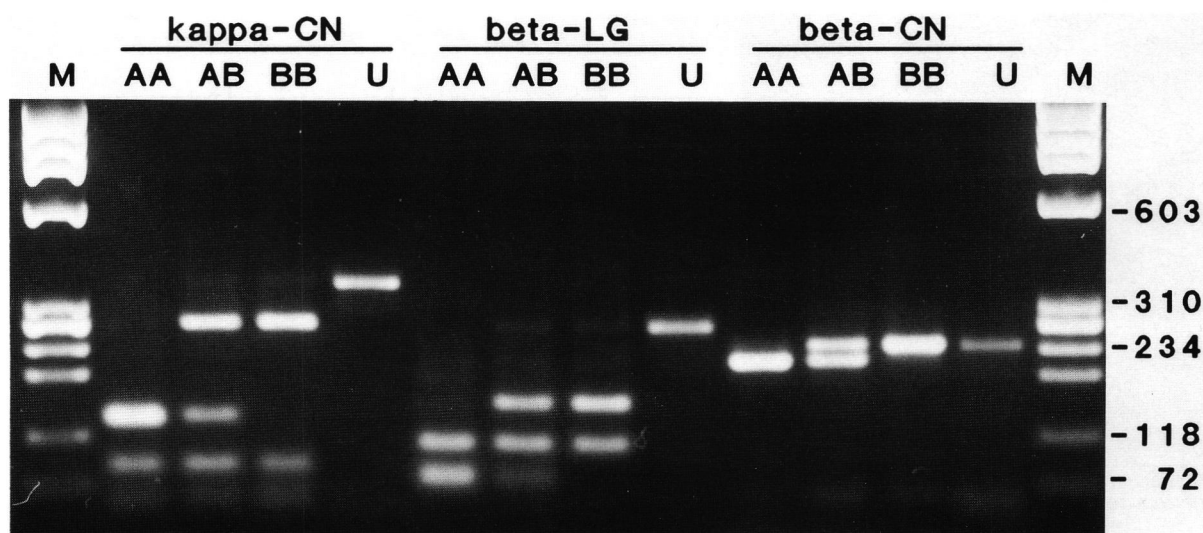

Figure 1. Gel showing the electrophoretic separation of DNA fragments to classify the AA, AB, and BB genotypes of  $\kappa$ -casein,  $\beta$ -lactoglobulin, and  $\beta$ -casein. U indicates intact DNA fragments before enzymatic digestion for classification. M, size marker.

produce 80% more  $\kappa$ -casein B protein than the A protein type, suggesting that the B allele of  $\kappa$ -casein has an elevated level of expression in cow's milk. The amount of  $\kappa$ -casein present in milk is important in cheese making because of its effect on the physical properties of the casein micelles. Milks from  $\kappa$ -caseinAA cows have an increased population of large micelles, whereas BB cows have smaller, more homogeneous micelles. Smaller micelles allow for the formation of a firm coherent curd in cheese making. The formation of a dense coagulum retains a greater proportion of solids in the curd, which results in an increased cheese yield.

In collaboration with Dr. Famula, we are critically evaluating and developing appropriate statistical procedures to ascertain the significance of molecular markers in relation to production traits in dairy cattle. As part of this work, we have demonstrated that the estimation of milk protein genotype effects from the sire transmitting abilities (PTA), in cases in which the bulls have been genotyped, gives biased results. Hence, the appropriate analysis leading to practical conclusions on the significance of molecular markers is to analyze directly the production records of the genotyped animals.

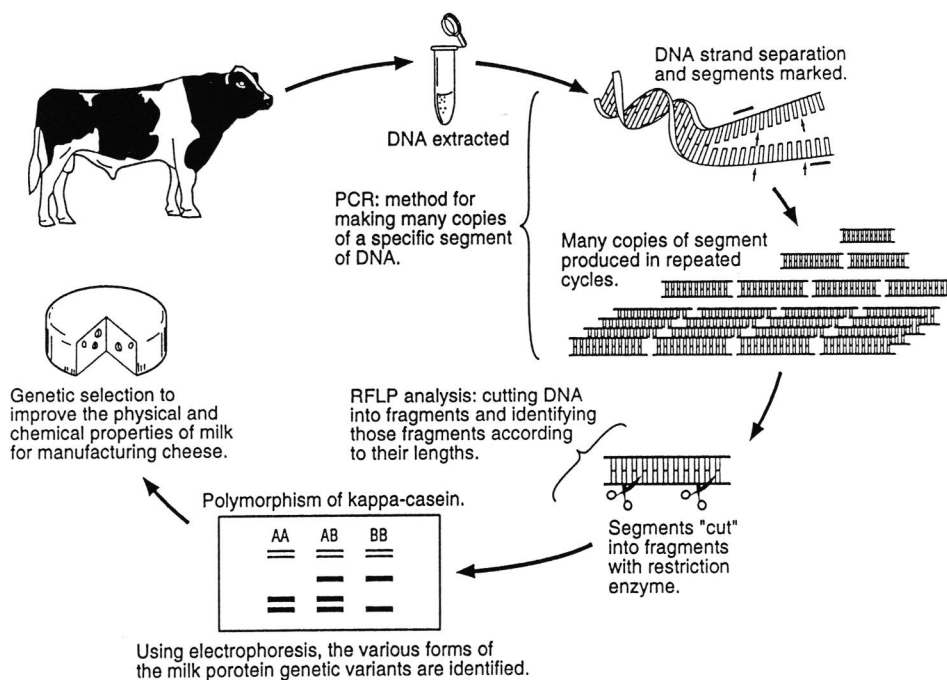

Figure 2. Diagram showing the procedure to analyze a DNA sample to classify the  $\kappa$ -casein milk protein polymorphism. (PCR: polymerase chain reaction. RFLP analysis: restriction fragment length polymorphism.)

Dr. Medrano teaches ASM 150, Applied Statistics in Agricultural Sciences; and ANG 107, Genetics and Animal Breeding.



---

---

## ENDOCRINE CONTROL OF REPRODUCTION OF CULTURED WHITE STURGEON (*Acipenser ansmontanus*)

Gary P. Moberg

The value of sturgeon flesh and the demand for caviar makes the culture of sturgeon an exciting opportunity for aquaculture worldwide. Recently in California, several private aquaculture ventures have begun to raise white sturgeon for the commercial market. While suc-

We plan to determine if such testosterone treatment can be used to induce sufficient gonadotropin synthesis and release to initiate gonadal development, thus providing a reliable source of captive broodstock for the aquaculture industry.

cessful in producing marketable fish, they have not been able to raise a reliable source of domestic female broodstock and must continue to harvest wild broodstock for eggs. Females raised in culture remain reproductively immature until 7 to 10 years of age. Reproduction in these females is arrested just prior to the initiation of vitellogenesis.

From our earlier research, it appears that the hypothalamic-pituitary-gonadal axis of the cultured females is not secreting sufficient gonadotropins to induce the full maturation of the reproductive system. Therefore, to promote earlier sexual maturation of captive sturgeon broodstock we are attempting to induce reproductive maturity by hormone treatment. However, for such hormonal manipulation to be successful, it is

necessary first to understand the role of the hypothalamic-pituitary-gonadal axis in regulating the reproduction of sturgeon.

We have isolated from sturgeon pituitary extracts two gonadotropins that appear to regulate reproduction and have developed radioimmunoassays to measure these hormones during reproduction. We have found that one of the gonadotropins, GTH14, appears to be responsible for development of the ovary and the initiation of vitellogenesis.

The second gonadotropin, GTH20, increases prior to final ovarian maturation and seems to initiate the final ovarian maturation and spawning. In the immature sturgeon the pituitary content of both of these gonadotropins is low, and it is not possible to initiate the secretion of the hormones by administering their releasing hormone, GnRH.

Recently, we have found that in immature sturgeon the pituitary content of these gonadotropins can be increased by treatment with exogenous testosterone. We plan to determine if such testosterone treatment can be used to induce sufficient gonadotropin synthesis and release to initiate gonadal development, thus providing a reliable source of captive broodstock for the aquaculture industry.

Dr. Moberg teaches PHS 130, Physiology of the Endocrine Glands; and PHS 230, Advanced Endocrinology.

---

---

## INFLUENCE OF STRESS ON REPRODUCTION OF RUMINANTS

Gary P. Moberg

Stressors associated with intensive livestock management may be responsible for the reduced reproductive efficiency observed in domestic animals maintained under confinement conditions. To achieve normal reproductive rates in these animals, it is necessary to develop management schemes that alleviate the effects of such management related stresses. Before we can design appropriate management schemes, however, we must develop an understanding how such stressors disrupt normal reproduction of domestic ruminants.

Reproduction of the female, especially during the period preceding ovulation, seems to be especially sensitive to the adverse effects of stress.

Reproduction of the female, especially during the period preceding ovulation, seems to be especially sensitive to the adverse effects of stress. Follicular development and ovulation require a complex and delicate interplay between the pituitary gonadotropes and the feedback actions of the major follicular steroid, estradiol. It is this complexity that makes the regulation of the follicular stage of the estrous cycle and ovulation vulnerable to stress. Although the pathophysiological mechanisms by which stress disrupts reproduction

are not fully understood, one critical factor seems to be the stress-induced secretion of adrenal glucocorticosteroids, such as cortisol. This steroid can disrupt both the synthesis and the secretion of the gonadotropins, luteinizing hormone (LH), and follicle stimulating hormone (FSH).

We have found that a variety of management-related stresses that induce the secretion of cortisol also reduce the effectiveness of the hypothalamic factor gonadotropin-releasing-hormone (GnRH) in stimulating the secretion of LH, a necessary component of ovulation. To understand the mechanism of action of cortisol on LH secretion, we have used both *in vitro* and *in vivo* studies of the sheep pituitary. From these studies we have found that cortisol expresses this inhibitory effect four hours after the pituitary cells have been exposed to elevated concentrations of the steroid. Our recent results indicate that this delay in action is the time it takes for cortisol to block the synthesis of arachidonic acid, an important cellular component of LH secretion. Thus, by this mechanism we believe that the stress-induced secretion of cortisol can reduce the amount of LH being secreted sufficiently to block normal ovulation.

---

---

## WASTE MANAGEMENT ISSUES

**Deanne Morse**

Before my arrival at UC Davis in 1992, waste management issues were largely the concern of our Extension dairy advisors. In my new position, I will attempt to address manure management issues pertinent to environmental concerns such as air and water quality. Previously, waste management research has been carried out by Extension's dairy advisors.

I expect to work closely with private and governmental organizations that are concerned about proper waste management. Cooperative efforts are essential among dairy, poultry, swine, and cattle producers, SCS, ASCS, state and regional water and air quality boards, resource conservation districts, environmental groups, departments of fish and game, and other interested parties. My initial

focus is to establish communications and develop a working relationship with these organizations. I hope these cooperative efforts will result in the development of educational materials to inform law- and policy-makers, as well as the development of acceptable and economically-achievable management practices for the animal industries.

Ample opportunities exist for research. Waste management research requires access to individuals in many disciplines. It is important to address areas that will make the greatest impact on water quality in the shortest time. Two critical components are nutrient budgeting (application of an acceptable quantity of nutrients) and irrigation and manure water management.

Deanne Morse is a Cooperative Extension Specialist in Animal Science.

## THE GENETIC CONTROL OF GROWTH AND BODY COMPOSITION

James D. Murray

Understanding the genetic and metabolic parameters underlying growth processes is a prerequisite to being able to modify or control these processes selectively for increased animal production efficiencies and the provision of leaner, healthier meat. The production of selective models by genetic engineering should help us to advance our understanding of these processes. We are currently describing the growth characteristics of a line of transgenic mice that carry the ovine growth hormone (oGH) gene, which in these mice is under the control of a switch element that allows the expression of the gene to be turned on or off by the provision or withdrawal of zinc in the drinking water.

When the oGH transgene is activated at weaning, the transgenic mice grow approximately 50% larger by 70 days of age than their non-transgenic, control littermates (Fig. 1). Our recent

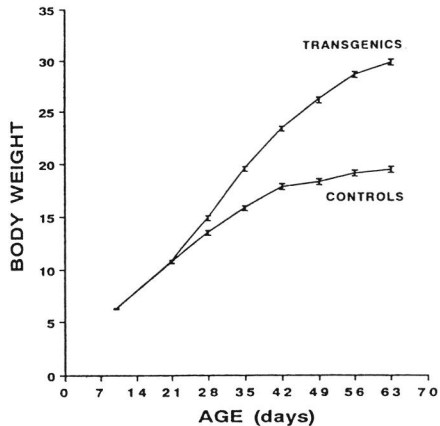

Figure 1. Growth curves of transgenic and control female mice.

work has determined that this increase in growth is accomplished with an increase of only 11% in feed consumption; in other words, the transgenic mice are more efficient at converting feed into body mass. While these mice do have

increased hind carcass mass when compared to the controls, a smaller proportion of body mass is represented as lean muscle. The major fat depots in the transgenic mice are also smaller compared to control mice on an adjusted body weight basis. Our conclusion is that the transgenic mice expressing the oGH gene are more efficient at producing lean growth at virtually any age studied than are the control animals.

A second recent observation is that oGH-expressing transgenic mice have increased levels of long-chain polyunsaturated fatty acids in serum and liver tissue (Fig. 2). The overall tissue distribution of these changes are not yet known nor are the physiological consequences. Increased levels of arachidonic acid may be associated with a variety of health problems including reduced immune function, increased levels of joint inflammation, and cardiovascular disease.

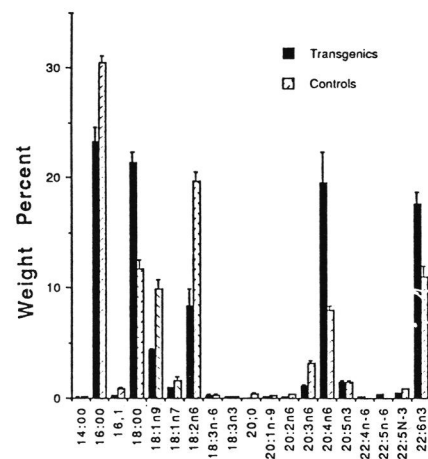

Figure 2. Percent weight of major fatty acids in liver membrane phosphatidylcholine.

While these transgenic mice certainly are not livestock animals they may prove to be an extremely valuable research model in our attempts to unravel the genetic and metabolic control of lean tissue growth and fatty acid composition.

Dr. Murray teaches ANG 111, Molecular Biology Laboratory; ANG 211, Genetic Engineering of Animals; and GGG 201B, Cytogenetics.

## BONE GROWTH IN GROWTH HORMONE TRANSGENIC MICE

Anita M. Oberbauer

Growth hormone (GH) regulates postnatal growth in mammals, particularly bone elongation and body composition alterations. Although the effects of GH replacement have been well documented, the long-term metabolic and body composition consequences of even short-term GH administration in a GH-replete animal are currently unknown. Knowledge of GH action is critical given that clinical GH applications are expanding beyond therapeutic replacement in human subjects, while the livestock industry is investigating GH's potential to generate more desirable carcasses. Furthermore, because the goal of livestock production centers on the genetic improvement of growth, basic information pertaining to developmental processes is of utmost importance.

To better understand the role of GH in linear bone growth, a mouse line transgenic for the sheep GH gene was studied. In these mice a sheep metallothionein promoter can be used to control expression of the GH transgene. A low concentration of zinc added to the animal's drinking water is sufficient to activate expression of the GH transgene. Transgenic and nontrans-

genic control mice were sampled at 10-day intervals until maturity (130 days of age) and the lengths of ulna, tibia, and humerus were measured at each sample age.

Zinc supplementation of transgenic mice elevated circulating GH levels 3,000% relative to levels measured in nontransgenic control mice. This increase translated into significantly longer bones in the transgenic mice as compared to control mice (Fig. 1 below). Bones from mice overexpressing GH were up to 20% longer than those from controls at 130 days of age ( $P < 0.001$ ). Transgenic mice exhibited both an enhanced rate of bone growth and a growth period of greater duration due to delayed growth plate closure. That is, the ulna, tibia, and humerus from the transgenic mice grew at an accelerated rate for an additional 20 to 40 days relative to the same bones from control mice. The bones from both groups were characterized by isometric growth patterns, and the observed length differences were directly related to the final size of the animal, indicating that bones possess an inherent growth pattern that is followed even in the presence of elevated GH.

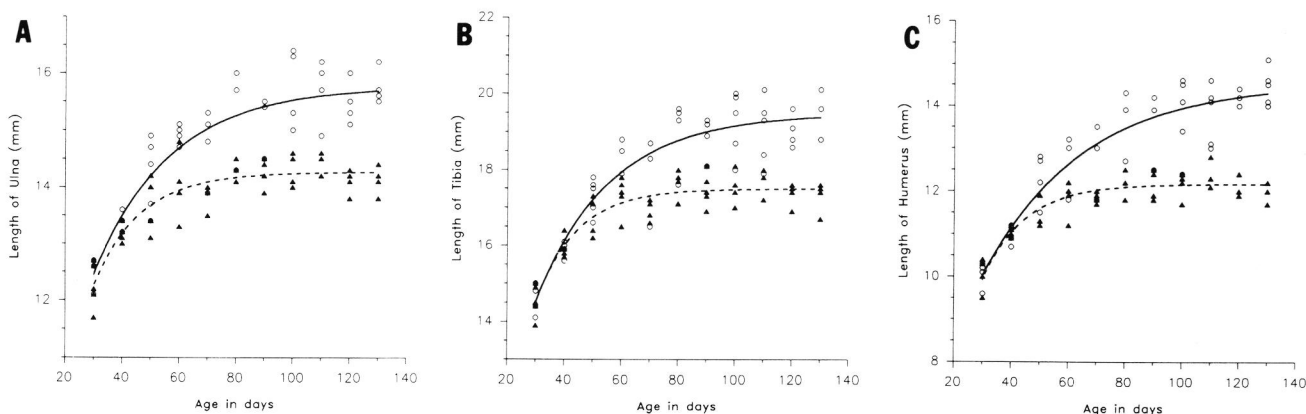

Figure 1. Bone lengths for transgenic (open circles) and nontransgenic control mice (closed triangles).

---

## CALIFORNIA FEEDLOT QUALITY CERTIFICATION PROGRAM

James W. Oltjen

In winter, 1989, the California Cattlemen's Association Feeder Council began work with University of California Cooperative Extension personnel to develop a quality assurance program. A Quality Certification Program was introduced in February, 1992, to California's feedlot industry. The program's goal is to promote good management practices that produce cattle that are healthy and wholesome and meet FDA, USDA, and EPA regulations. This voluntary program demonstrates to consumers and to government that cattle feeders are willing to accept responsibility for assuring a safe beef supply. The Quality Certification Program, now being implemented throughout the state, is supported by a grant from the California Beef Council.

The program offers feedyard owners and employees training in animal health and feed handling procedures and safety to ensure high quality beef production. Feedyards will sample and test main rations for pesticides on a quarterly basis and certify that only approved feed



Dr. Juan Guerrero, right, UC Cooperative Extension Livestock Advisor, conducts QCP laboratory training in feed handling in the Imperial Valley.

additives are used and that all additives are withdrawn according to law to avoid violative residues. Medication of individual animals will follow treatment schedules developed in consultation with a veterinarian and recorded by the feedyard. All animals scheduled for slaughter will be checked to assure proper withdrawal times have been met. The feedyards also assure that only state and federally-approved pesticides have been used for cattle treatment. All records of rations fed, feed additives added to specific rations, and individual animal treatments will be maintained by the feedyard for 90 days after slaughter. These records will be available to UC research personnel. Compliance audits will be performed annually to check individual treatment records, feed medication records, and quarterly main ration assays.

In 1992, I coordinated two training programs for employees of 29 feedlots in Brawley and Fresno. Ben Norman, Extension Beef Cattle Veterinarian, and John Dunbar, Livestock Nutritionist, were responsible for the Animal Health and Feed Handling training programs, respectively. Juan Guerrero and Aaron Nelson, UC Cooperative Extension Livestock Advisors, assisted the Specialists in the training programs. Several local feedlot veterinarians helped in the hands-on feedlot laboratories. The program was available in Spanish, and handbooks for Animal Health and Feed Handling were developed and distributed to participants. Attendance at the Feed Handling Training was 67, and 121 for the Animal Health Training. All who completed the training received Certificates of Completion.

California cattle feedyards have an excellent record of residue avoidance. Through voluntary participation in the CCA Feeder Council Quality Certification Program, the cattle feeding industry can continue to produce safe, wholesome beef in a manner that continues to inspire consumer confidence and can base its future certification on scientifically developed California data and training.

Jim Oltjen is an Associate Cooperative Extension Specialist.

---

---

## WATER USE FOR BEEF PRODUCTION IN THE UNITED STATES

James W. Oltjen

Recent publications such as John Robbins' *Diet for a New America* (1987) and information from The Water Education Foundation (1992) in Sacramento have given exceptionally high estimates of the water requirements for beef production.

These estimates were derived from faulty assumptions and over-

simplifications. The diversity of production systems in use throughout the United States requires a more complex approach to the question. In an effort to discover more realistic and representative figures, we designed a beef industry model to quantify total developed water used across the variety of production systems nationwide; from the data in that model we calculated what we believe to be a more accurate average water use requirement for beef production.

The types of water used for raising beef cattle were divided into drinking water, water used for feed production, and water used for processing the cattle into boneless beef. On a state by state basis we took into account such factors as numbers of cattle raised; direct consumption equations for different classes of animals such as lactating cows, weaned calves, bulls, etc.;

differing irrigation requirements for various feed crops and irrigated pasture; and water used by commercial slaughter facilities to process beef carcasses into trimmed, boneless beef. The total amount of water consumed directly by the cattle in the United States is 200 billion gallons per year. We calculated the amount of water applied to irrigated alfalfa, barley, corn, corn silage, grain sorghum, and wheat as well as the water applied to irrigated pasture. Irrigated crop feedstuffs for beef cattle used 3,431 billion gallons of water annually, and irrigated pasture for beef cattle production accounted for another 2,970 billion gallons. Water used for processing the carcasses added another 21 billion gallons to the production requirement.

Based on these figures, the model estimated that 441 gallons of water are required to produce a pound of trimmed, boneless beef.

We concluded that the amount of water required for beef production under the current management practices in the United States is substantial, but the actual amount is far less than previously suggested. Further, irrigated pasture and feedstuff production account for the majority of the water requirement for beef production.

We concluded that the amount of water required for beef production under the current management practices in the United States is substantial, but the actual amount is far less than previously suggested.

---

---

## FOSTERING LAMBS

Edward O. Price

Ewes ultimately rely on odor cues to identify their own offspring. It follows that fostering might be facilitated if alien lambs were artificially made to smell like their foster mother's natural young. My students and I have investigated a way to transfer odor from own to alien lambs using inexpensive cloth stockinette jackets. When fostering a second lamb (alien) to a ewe with a lamb of her own (add-on mode), a 4-inch diameter tubular nylon stockinette is placed on both lambs shortly after birth (Fig. 1). Twenty-four hours later the jackets are exchanged between lambs and the alien is introduced to its new mother.

This research will appeal to sheep breeders seeking an easy and more cost-effective way to rear orphaned lambs.

In one study, 21 of 31 ewes (68%) accepted jacketed alien lambs in addition to their own young. Forty-two percent accepted the alien lambs immediately upon presentation.

Fostering success is even greater when the odor transfer technique is used to substitute alien for natural lambs. Nineteen of 21 ewes (90%) adopted alien lambs substituted for their own lambs 48 to 72 hours after parturition. Over 40% of these adoptions were immediate.

Sheep breeders in North America and other countries are now using the odor-transfer method for fostering lambs, and stockinette jackets are being marketed commercially.

A slightly different approach involving olfaction was begun in 1992. A novel odor (neatsfoot oil) was placed on both the natural and alien lambs within 12 hours of birth, the objective being to establish an artificial common odor on the two lambs. The oil was applied using stockinettes which were then placed on the lambs.

Twenty-four hours later the stockinettes were exchanged and the alien was introduced to its foster mother. Twenty of 25 ewes ( 80% ) accepted alien as well as own lambs within 24 hours, and adoptions were immediate in two-thirds of the cases.

In 1993, we will continue our investigations with odor transfer and novel odorants, as well as begin fostering trials using vaginal-cervical stimulation. Mechanical distention of the vagina and cervix of the ewe is known to cause the release of oxytocin, a hormone which is normally secreted during the birthing process and which facilitates the expression of maternal behaviors. Our goal is to achieve a 90% adoption rate for alien lambs in the add-on mode with 90% immediate acceptance. This research will appeal to sheep breeders seeking an easy and more cost-effective way to rear orphaned lambs.

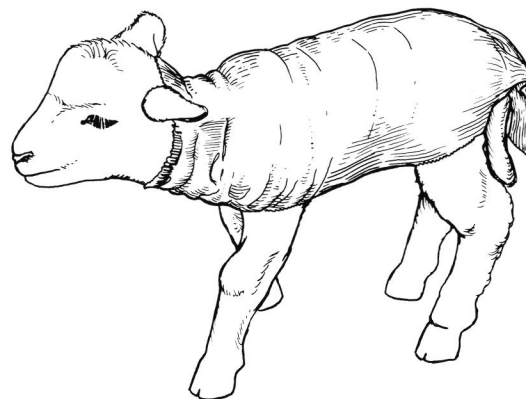

Figure 1. Cloth stockinette jacket on lamb.

Dr. Price teaches ANS 104, Principles of Domestic Animal Behavior; ANS 105, Behavioral Adaptations of Domestic Animals; ANS 106, Domestic Animal Behavior Laboratory; VMD 170, Ethics of Animal Use; and ANB 220, Behavioral Aspects of Animal Domestication.



## SEASONAL EFFECTS ON SEMINAL QUALITY, PLASMA HORMONE CONCENTRATIONS, AND GnRH-INDUCED LH RESPONSE IN FERTILE AND SUBFERTILE STALLIONS

Janet F. Roser

Seasonal effects on hormonal and seminal parameters in subfertile stallions have not been well documented and could provide information that is needed to understand the underlying endocrine mechanisms associated with testicular dysfunction. Such information may be useful in developing diagnostic tools to identify which stallions are candidates for treatment. The objective of this investigation was to characterize and compare the effects of season on endocrine function and seminal quality in fertile and subfertile stallions. Eight fertile and 6 subfertile stallions between the ages of 5 and 18 years were injected intravenously (i.v.) once every hour for three hours with either 1 ml of saline on the first experimental day or 5 µg of GnRH in 1 ml saline on the second experimental day during the non-breeding and breeding season. Heparinized blood samples were collected periodically prior to and over the next six hours and analyzed for luteinizing hormone (LH), follicle stimulating hormone (FSH), testosterone (T), and estrogen conjugates (EC) by radioimmunoassay. Semen samples for semen analysis were collected twice one hour apart on all stallions in both seasons.

A series of low doses of GnRH induced a significant LH response ( $p < 0.05$ ) compared to the saline treatment in both fertile and subfertile stallions. The magnitude of the LH response relative to baseline in fertile stallions was significantly higher ( $p < 0.05$ ) in the non-breeding season than the breeding season (Fig. 1).

Season did not have an effect on the LH response in subfertile stallions (Fig. 1). The magnitude of the LH response relative to baseline was lower ( $p < 0.05$ ) in the subfertile stallions ( $141 \pm 14\%$ ) compared to fertile stallions ( $235 \pm 46\%$ ) in the

non-breeding season and similar between the two groups in the breeding season. Compared to the fertile stallions, subfertile stallions had 2- to 4-fold higher ( $p < 0.05$ ) plasma levels of gonadotropins and similar T levels. Total progressively motile sperm (TPMS) was lower ( $p < 0.05$ ) in subfertile stallions compared to fertile stallions in both seasons. Basal hormone levels and TPMS were significantly influenced by season in the fertile group but not in the subfertile group. EC levels were not influenced by season in either group of stallions, although basal levels were highly correlated with several seminal characteristics in both fertile and subfertile stallions. Specifically, a sub-population of subfertile stallions was characterized by low EC levels and low sperm concentration in both seasons.

In conclusion, we have provided evidence that the functional hypothalamic-pituitary-testicular axis is altered in subfertile stallions and that this alteration in terms of the magnitude of the LH response relative to baseline after administration of low doses of GnRH is most easily observed in the non-breeding season. Furthermore, a sub-population of subfertile stallions appears to have low plasma levels of EC associated with very low sperm concentrations.

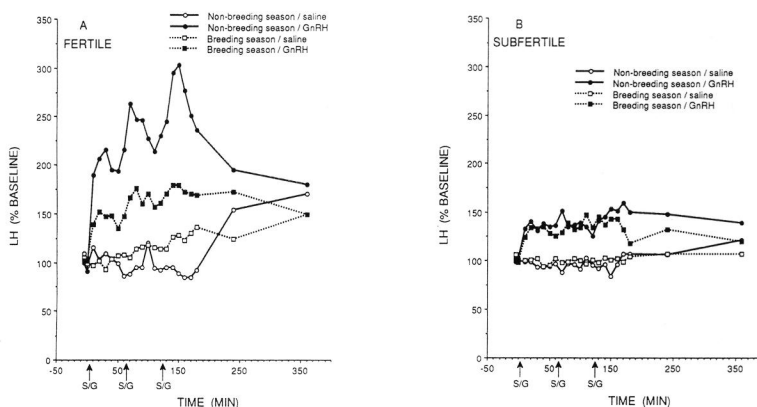

Figure 1. Temporal changes in the LH response, expressed as % baseline, to pulses of saline (S) or GnRH (C) in fertile ( $n=8$ ) and subfertile ( $n=6$ ) groups of stallions during the nonbreeding and breeding seasons.

Dr. Roser teaches ANS 15, Introduction to Horse Management; ANS 49, Animal Management Practices; ANS 115, Advanced Horse Production; and ANS 141, Equine Enterprise Management.

## REGULATION OF STEROIDOGENESIS IN CULTURED EQUINE TESTICULAR CELLS

Janet F. Roser and Karen M. Eisenhauer

This is an example of graduate student research being conducted in Dr. Roser's laboratory.

Studies in our laboratory using exogenous GnRH have demonstrated specific endocrine differences in pituitary function between fertile and subfertile stallions, but the exact cause of the hormonal disorder and how it affects testicular function have not been fully elucidated. A better understanding of the endocrine role in testicular function is essential background for the evaluation and management of the subfertile animal with endocrine dysfunction.

Our specific aim in this study was to examine the regulation of testicular steroidogenesis in normal stallions by investigating the effects of luteinizing hormone (LH), prolactin (PRL), and lipoproteins (LP) on testosterone (T) and estrogen conjugate (EC) production in cultured equine testicular cells. Enzymatically dispersed testicular cells from stallions 2 to 4 years of age were cultured for 12 hours either alone or with varying doses of LH, PRL, and/or lipoproteins.

EC and T production were determined by radioimmunoassay. Cell populations were characterized by electron microscopy and immunocytochemistry for the aromatase enzyme. Cell populations consisted of 36 to 46% Leydig cells, 2 to 3% Sertoli cells, and 62 to 68% immature and mature sperm cells. Lipoprotein dramatically increased ( $p < .005$ ) basal and LH-stimulated EC and T release in a dose-dependent manner. LH significantly ( $p < .001$ ) stimulated EC and T production in the presence of lipoproteins (Figs. 1a and 1b). The increase in T production (444-1289%) was significantly greater than the increase in EC production (278-411%). PRL had no effect on EC or T production either alone or when co-incubated with a physiological dose of LH.

In conclusion, both EC and T production in the stallion appear to be regulated by LH, and this regulation may be dependent on the availability of lipoprotein-derived cholesterol. EC production appears to be less responsive to LH than is T production.

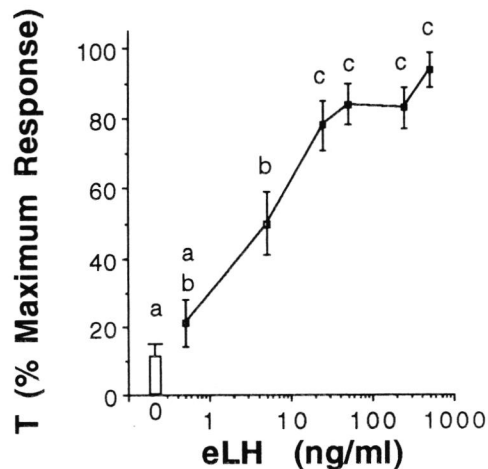
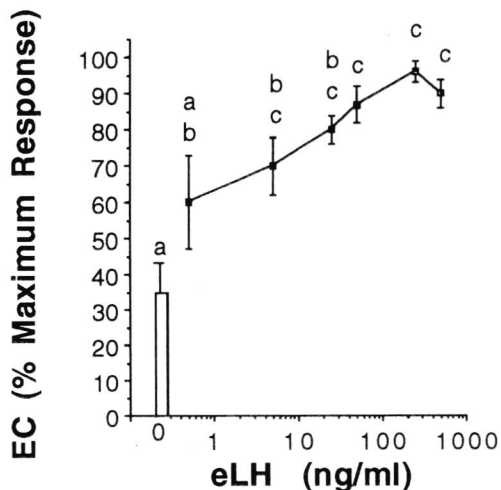

Figures 1a and 1b.

Karen Eisenhauer is a Ph.D. student in Dr. Roser's laboratory.

---

---

## VALUE-BASED MANAGEMENT OF BEEF CATTLE

Roberto D. Sainz

In response to consumer demand for high-quality lean beef, the beef cattle industry is moving towards improved systems for marketing cattle based upon their ultimate value at the retail counter. This will require improved methods for discriminating among animals that vary in meat yield and quality. In addition, production systems must be adapted to produce carcasses of given specifications within acceptable limits, *i.e.*, with minimal variation in yield and quality characteristics. This project aims to develop techniques for quantitative assessment of carcass composition in live

animals and to integrate these techniques with current knowledge of nutrition and growth physiology into a dynamic and robust mathematical model of beef cattle growth. At present, state-of-the-art ultrasound technology is being evaluated with regard to prediction of muscle and fat proportions in the live animal; these estimators of biological type will be used as input to a detailed model of steer growth to predict performance and quality characteristics of steers on feed. This will enable subsequent development of knowledge-based management and feeding systems for the beef industry.

---

---

## MECHANISMS OF PROTEIN METABOLISM IN SKELETAL MUSCLE

Roberto D. Sainz

Living cells are made up of a seemingly endless variety of proteins, comprising structural, contractile and enzymatic elements, among others. These proteins are continuously synthesized and broken down by specific enzyme systems. Factors controlling muscle growth (*i.e.*, accumulation of protein) must alter either synthesis or breakdown or both. This project aims to elucidate the mechanisms controlling breakdown of muscle proteins. Specifically, the functions of calcium-dependent proteases (calpains I and II) and their endogenous inhibitor (calpastatin) are being inves-

tigated. These enzymes have been implicated in the control of muscle growth and meat tenderness. To date, nutritional effects on calpain and calpastatin activities have been identified (Table 1). Current efforts are directed at identifying the mechanism(s) responsible for changes in activity, *i.e.*, expression of calpain and calpastatin genes, stability of the respective messenger RNA, or changes in translational efficiency. This information may prove useful in the development of techniques to manipulate muscle growth in healthy and diseased individuals.

Table 1. Effects of feed intake on growth and calpains in porcine *masseter* muscle

Intake group:	<i>Ad libitum</i>	Restricted	Pooled SD	P
Ave. feed intake, kg/d	2.60	2.12	.07	***
Ave. daily gain, kg/d	1.098	.812	.090	***
Calpain I, U/g	.131	.255	.126	*
Calpain II, U/g	1.962	2.456	.684	NS
Calpastatin, U/g	2.056	.658	.337	***

Statistical significance: \*,  $P < 0.05$ ; \*\*\*,  $P < 0.001$ .

Dr. Sainz teaches ANS 49, Animal Management Practices; ANS 123, Animal Growth; and ANS 144, Beef Cattle and Sheep Production.

---

---

## RUMINAL ESCAPE PROTEIN FOR LIGHT-WEIGHT FEEDLOT CATTLE

Richard A. Zinn

The objective of this study was to evaluate growth-performance responses of light-weight feedlot calves to an increased supply of post-ruminal amino acids.

The protein requirements of light-weight feedlot calves fed for rapid growth during the early growing and finishing phase has not been investigated extensively. Consequently, protein allowances during this phase are based on more generalized factorial assessments of expected metabolic costs. Implicit in the factorial system is the

assumption that the growth-performance response is ultimately dependent on the post-ruminal amino acid supply to meet tissue needs so that requirements are influenced extensively by growth rate. When the post-ruminal supply of "limiting" amino acids is adequate to fulfill the requirements for net tissue synthesis, no further growth or performance response to added protein would be expected. The objective of this study was to evaluate growth-performance responses of light-weight feedlot calves to an increased supply of post-ruminal amino acids.

Effects of supplemental ruminal escape protein (REP) were evaluated in an 84-day study involving 140 feedlot steers (average live wt, 198 kg) and in a site-of-digestion study involving four steers (av. 149 kg). Dietary treatments were as follows: 1) basal diet; 2) basal diet plus 2% of a REP

blend (1/3 blood meal, 1/3 meat and bone meal, and 1/3 feather meal); 3) basal diet plus 4% REP; and 4) basal diet plus 6% REP. The basal diet contained 18% alfalfa hay, 10% sudangrass hay, 61% steam-flaked corn, 2.5% yellow grease, 6% molasses, and 2.5% supplement. The basal diet contained 12.2% complete protein, with urea as the sole source of supplemental nitrogen. There was a quadratic effect ( $P < .05$ ) of REP supplementation on rate and efficiency of gain. The greatest response was with 2% REP, which increased rate and efficiency of gain by 13.4% and 8.4%, respectively, over that of the basal diet. Protein supplementation had a quadratic effect ( $P < .05$ ) on the net energy value of the diet. The addition of 2% of supplemental REP increased the net energy of the diet 6.6%.

In the site-of-digestion trial, supplemental REP linearly increased ( $P < .01$ ) passage of non-ammonia and amino acid nitrogen to the small intestine. Compared to estimated amino acid requirements and to muscle composition, post-ruminal supplies of arginine, histidine, lysine, methionine, and phenylalanine were the limiting amino acids in the basal diet. Excess bypass protein, by placing an additional demand on arginine for detoxification of ammonia, may limit growth and performance.

Dr. Zinn teaches ANS 144, Beef Cattle and Sheep Production.

## JUDGING PROGRAM

---

### ANIMAL JUDGING PROGRAM

Dana Van Liew

The Animal Science Judging Program continues to be an integral component of the Department's undergraduate curriculum. Strong class enrollment and enthusiastic student participation in competitions and related activities have all encouraged continued support by the Department and College. Alumni,

Alumni, industry leaders, and parents of judging team members support and promote the numerous benefits participants gain through their training and experiences.

industry leaders, and parents of judging team members support and promote the numerous benefits participants gain through their training and experiences.

According to John L. Braly, Executive Vice President of the California Cattlemen's Association and member of the 1979

UC Davis Collegiate Livestock Judging Team, "The Departmental Judging Program provides valuable training and experience for tomorrow's industry leaders."

Both the Department and the Davis campus are well aware of the public relations and student recruitment value of the judging teams' activities and their service. Student judging teams were recognized this year by the Dean of the College of Agricultural and Environmental Sciences for their extensive involvement with the annual Agricultural Science Field

Day. Team members are found in leadership roles in numerous activities on and off campus.

The 1992 Collegiate Livestock Judging Team earned both individual and team honors at many regional and national competitions. Charles Van Riper led the team to reserve champion honors at the Arizona National in January, 1992, and won high individual honors as well. Wendy Gibson set the pace at the prestigious Denver Stock Show, placing second in the cattle carload competition and anchoring the team's third place position. In Denver, the Gelbvieh Association presented the team, as winners of the performance bull judging competition, with stylish jackets. Carmen Mayo, Justin Reels, and Chris Simas excelled in beef and swine judging at the Fort Worth competition, helping the team secure a sixth place finish. Carmen and Wendy placed second and fifth, respectively, at the Great Western in Tulare, while the team won the beef cattle division and finished third overall. The fall contest performances included High Team Overall at the Pacific International in Portland, Oregon, and eighth place at the National Intercollegiate Livestock Judging Contest in Louisville, Kentucky. The team was also second in sheep judging, eighth in oral reasons, and ninth in beef cattle judging.

Dana Van Liew coaches the Animal Science Collegiate Livestock Judging Team. He also teaches ANS 21, Livestock and Dairy Cattle Judging and ANS 22A and B, Animal Judging.

## FUND-RAISING

### FUND-RAISING EFFORTS OF THE DEPARTMENT OF ANIMAL SCIENCE

James H. Meyer

Collaborative efforts of the Department of Animal Science with friends, alumni and industry groups has been underway for some time. The University is becoming a state-assisted University, not a state-supported one. State support for the Department has declined in the last two years, resulting in the loss of approximately 20% of the faculty and Extension specialist positions, 23% of staff, and a decline of 25%, 23%, and 39%, respectively in budgetary support for teaching, research, and extension. An additional 10 to 15% permanent budgetary reduction has been tentatively announced for 1993, and the Department anticipates a reduction in the number of graduate and undergraduate students in the next year.

Fortunately, the fund-raising committee of the Department Development Board, chaired by Ria de Grassi, has been meeting to develop a fund-raising plan. A major goal is to develop a program of external support for teaching, research, and extension functions as critical elements of service to the public. Specific fund-raising goals would be as follows:

1. An annual program of raising funds from alumni and friends for general support of teaching, research, and extension.
2. A specific annual fund-raising program for such programs as the judging teams, student field trips, etc.

3. Development of research funding for specific projects.
4. Development of endowments, particularly from deferred giving efforts.
5. Development of State funding for capital improvement such as animal and laboratory facilities.

The external Development Board is very important in providing guidance, oversight, and aid in the development of funding for the Department. Development of unified programs of research and extension activities is required whereby farm advisors, Extension specialists, and faculty work together on the research continuum—from the development of knowledge to the transfer of this knowledge to the public. A major effort is needed in all areas, from the animal to the environment to the quality of animal products for the public. Many industries and alumni, not only from the production segment but also from processing, financing, and the feed, equipment and trucking industries are recipients of the Department's efforts.

What is critical, therefore, is a collaborative effort including faculty, campus, and county Cooperative Extension personnel and those who benefit from and apply research results in private and public enterprises. What is being tested is whether a department such as Animal Science and its friends are able to develop an effective fund-raising program.

A major goal is to develop a program of external support for teaching, research, and extension functions as critical elements of service to the public.

Dr. Meyer, Chancellor Emeritus, is currently Chair of the Animal Science Development Committee and of the Research Policy Committee for the College of Agricultural and Environmental Sciences.



## INDEX

- |  |                                   |
|--|-----------------------------------|
| Adams, T. . . . .  | 18                                |
| Anderson, G.B. . . . .                                     | 19                                |
| Aquaculture . . . . .                                      | 11, 17, 29-33, 35, 40, 41, 43, 48 |
| Bacteria . . . . .   | 45                                |
| Baldwin, R.L. . . . .                                      | 20                                |
| Bath, D.L. . . . .   | 21                                |
| Behavior . . . . .   | 39, 55                            |
| Berger, T. . . . .   | 22                                |
| Berry, S.L. . . . .  | 17, 23                            |
| Bodega Marine Laboratory . . . . .                         | 11                                |
| Bradford, G.E. . . . .                                     | 7, 24                             |
| Brine shrimp . . . . .                                     | 31                                |
| Brown, D.L. . . . .  | 26, 27                            |
| Calvert, C.C. . . . .                                      | 28                                |
| Cats . . . . .   | 26                                |
| Cattle . . . . .   | 19, 26                            |
| beef . . . . .   | 17, 18, 20, 23, 24                |
| dairy . . . . .  | 11, 17, 19, 23, 28                |
| . . . . .  | 29, 28, 34, 38, 46                |
| . . . . .  | 36, 37, 53, 54, 58, 59            |
| Chang, E.S. . . . .  | 29                                |
| Clark, W.H. . . . .  | 30                                |
| Cole Facility . . . . .                                    | 11                                |
| Computer programs . . . . .                                | 21, 23, 33, 36                    |
| Conklin, D.E. . . . .                                      | 31                                |
| Conte, F.S. . . . .  | 32, 33                            |
| Crabs . . . . .  | 29                                |
| Crustaceans . . . . .                                      | 29, 31                            |
| De Grassi, Ria . . . . .                                   | 61                                |
| Deer . . . . .   | 26                                |
| DePeters, E.J. . . . .                                     | 21, 34                            |
| Development Board . . . . .                                | 61                                |
| Dogs . . . . .   | 39                                |
| Doroshov, S. . . . .                                       | 35                                |
| Dunbar, J.R. . . . .                                       | 36, 37                            |
| Endocrinology . . . . .                                    | 18, 28, 48, 49, 52, 57            |
| Extension . . . . .  | 17, 21, 33, 36, 50, 53, 54        |
| Facilities . . . . .                                       | 11                                |
| Faculty . . . . .  | 8                                 |
| Fadel, J.G. . . . .  | 38                                |
| Famula, T.R. . . . .                                       | 39, 47                            |
| Feedlot . . . . .  | 11                                |
| Fish . . . . .   | 11, 40, 48                        |
| Fund-raising . . . . .                                     | 61                                |
| Gall, G.A.E. . . . .                                       | 40                                |
| Garnett, I. . . . .  | 15                                |
| Genetics . . . . .   | 24, 39, 41, 46, 51                |
| Goats . . . . .  | 11, 22, 26, 27                    |
| Graduate Groups . . . . .                                  | 15                                |
| Hamster . . . . .  | 22                                |
| Hedgecock, D. . . . .                                      | 41                                |
| Horses . . . . .   | 11, 17, 36, 56, 57                |
| Howitt, R.E. . . . .                                       | 38                                |
| Humans . . . . .   | 26                                |
| Hung, S.S.O. . . . .                                       | 43                                |
| Judging Program . . . . .                                  | 60                                |
| Lee, Y.B. . . . .  | 44                                |
| Livestock . . . . .  | 17, 18, 20, 23, 24, 27            |
| . . . . .  | 36, 44, 49, 51-53, 59, 60         |
| Lobsters . . . . .   | 29                                |
| Macy, J. . . . .   | 45                                |
| Management . . . . .                                       | 17, 23, 32, 36-38, 40             |
| . . . . .  | 44, 46, 49, 50, 53, 58            |
| Master of Agriculture and Management<br>(M.A.M.) . . . . . | 14                                |
| Master of Science in Animal Science (M.S.) . . . . .       | 14                                |
| Medrano, J.F. . . . .                                      | 19, 46                            |
| Metabolism . . . . .                                       | 28, 34, 45, 51, 58, 59            |
| Meyer, J.H. . . . .  | 61                                |
| Mice . . . . .   | 19, 24, 27, 51, 52                |
| Moberg, G.P. . . . .                                       | 35, 48, 49                        |
| Morse, D. . . . .  | 50                                |
| Murray, J.D. . . . .                                       | 19, 51                            |
| Nutrition . . . . .  | 17, 21, 23, 27, 28                |
| . . . . .  | 31, 34, 36-38, 43, 59             |
| Oberbauer, A.M. . . . .                                    | 52                                |
| Oltjen, J.W. . . . .                                       | 36, 53, 54                        |
| Oysters . . . . .  | 32, 41                            |
| Physiology . . . . .                                       | 18-20, 22, 24                     |
| . . . . .  | 26-30, 35, 44, 52, 56             |
| Pork . . . . .   | 58                                |
| Price, E.O. . . . .  | 55                                |
| Rabbits . . . . .  | 26                                |
| Reproduction . . . . .                                     | 19, 22, 23, 28, 30                |
| . . . . .  | 31, 35, 48, 49, 56, 57            |
| Roser, J.F. . . . .  | 56, 57                            |
| Sainz, R.D. . . . .  | 58                                |
| Salmon . . . . .   | 40                                |
| Sheep . . . . .  | 17, 18, 24, 26, 44, 51, 55        |
| Shrimp . . . . .   | 29, 30                            |
| Sturgeon . . . . .   | 35, 43, 48                        |
| Swine . . . . .  | 11, 17, 22, 23, 26, 36            |
| Teaching . . . . .   | 14                                |
| graduate . . . . .   | 12                                |
| undergraduate . . . . .                                    | 60                                |
| Van Liew, D. . . . .                                       | 17, 50                            |
| Waste management . . . . .                                 | 17, 50                            |
| Zinn, R.A. . . . .   | 59                                |



